



Planned Phase Out
 Limited Stock Available While Supplies Last

THCV1UNV024V-100L



IP64



CE

RoHS COMPLIANT



Constant Voltage LED Driver

- Input Voltage:120-277V~, 50/60Hz
- Output Current:4.1A
- Output Voltage:24V---
- Output Power:100W Max.
- U-OUT:25V ---
- Long Case

General Specifications

Input Voltage / Frequency	120-277V~, 50/60Hz
Input Current	0.93A@120V, 0.41A@277V
Input Power	113W
Input PF	>0.9@277V 60%-100% Load
THD	<20%@277V 60%-100% Load
Efficiency	90%@230V Full Load
Inrush Current/Time	<90A @277V / 250us
Max Leakage Current	<0.7mA @240V per CE / <0.75mA@277V per UL
Output Voltage Range	24V---
Output Current	4.1A
Line Regulation / Load Regulation	<1% @100% Load / <3% @Full Load
Total Overall Ripple	<5% @Full Load
Low Frequency Ripple (120Hz ripple peak to peak)	<5% @Full Load
Flicker Percentage	<5%
Dimming Isolation	NA
Operating Ambient Temperature Range	-40°C to 51.3°C (-40°F to 124.34°F)
Maximum Driver Case Temperature (Tc) (Per UL)	86.9°C (188.42°F)
Start-up Time	<1000ms
Standby Power	NA
Driver Output Type / Number of Output Channels	Constant Voltage - LED Class 2 / 1 Channel
Overall Size	10.47" L x 1.69" W x 0.96" H (266mm L x 43mm W x 24mm H)
Wire Type / Length	18AWG / 11.8"
Weight	587g / 1.29lbs.
Safety / Compliance	EN61347-1, EN61347-2-13, UL8750,1310, UL879 cULus Listed Class P RoHS Compliant CE Suitable for Dry and Damp locations
IP Rating	IP64
Withstand Voltage	I/P-O/P:3000VAC, I/P-FG:1750VAC O/P-FG:500VAC
Insulation Resistance	I/P-O/P, I/P-FG, O/P-FG:100M Ohms/ 500VDC/25°C/70%RH
Potting Type / Degree of Fill	Potting As Per ASTM D36-86
EMC Emission	FCC Part 15B Consumer, EN55015,EN61000-3-2, 3
EMC Immunity	IEC61000-4-2,3,4,5,6,8,11,IEC61547
Operating Humidity	20-98% RH Non-condensing
Protections	Input Surge Line-Neutral 2KV, Line & Neutral-Ground 4KV(Ringwave 2.5KV / 2.5KV) Input Current Protection Output Short Circuit Protection(Recovers automatically after short is removed) Overload Protection Over Temperature Protection
Hot Swappable	No
Sound Rating	A
Service Life	50,000 hours lifetime @ Tc 86.9°C (188.42°F), see figure 4
Warranty	5 years @ Tc 86.9°C (188.42°F) from the date of manufacture

*FG = Fault Ground **I/P = Input Power ***O/P = Output Power

Typical Characteristics Graphs: Input

Figure 1

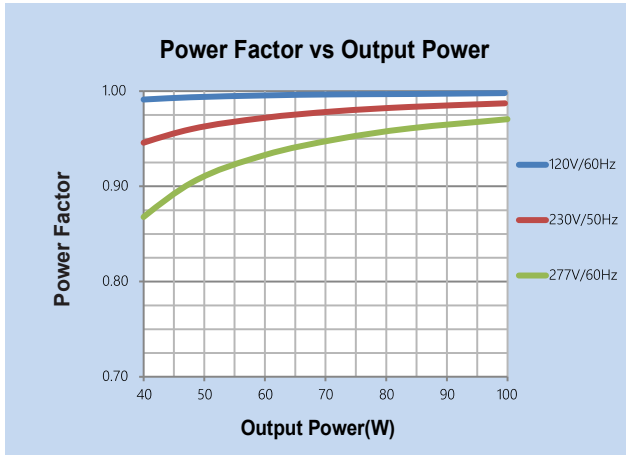

Figure 2

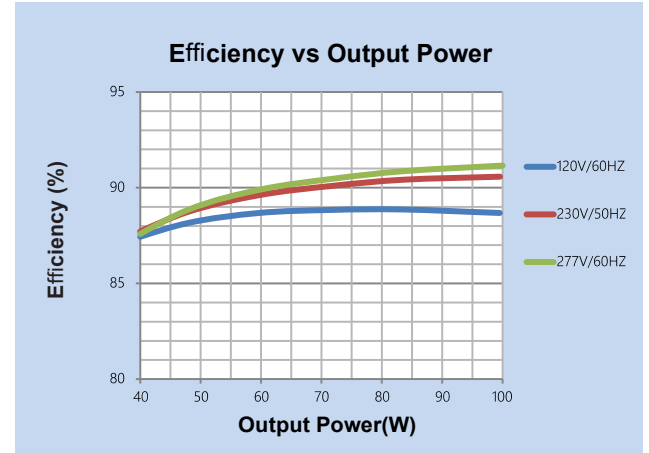

Figure 3

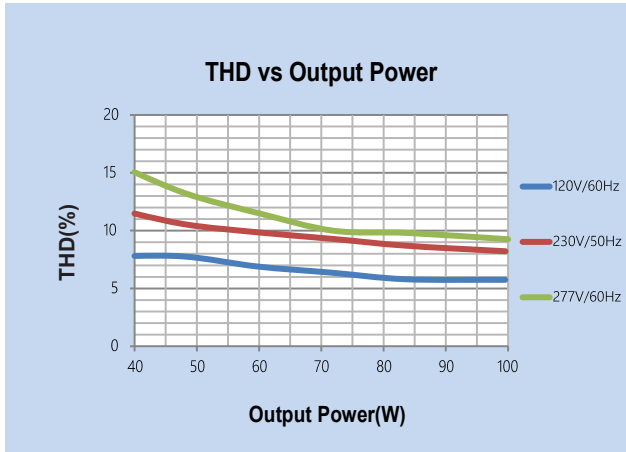
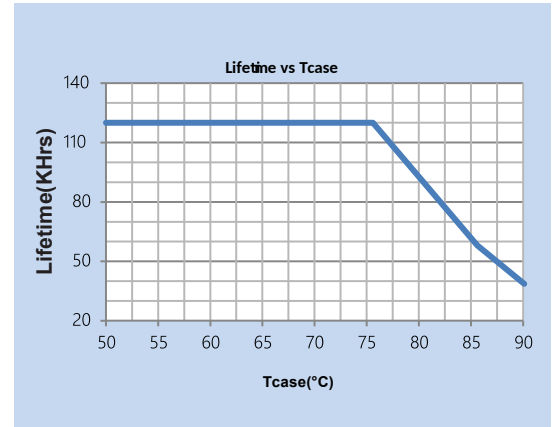

Figure 5



Failure Rate Info based upon MTBF modeling:
90% survivals at end of life @ ≤Tc lifetime rating

THCV1UNV024V-100L



IP64



RoHS COMPLIANT



MECHANICAL DATA

THCV1UNV024V-100L

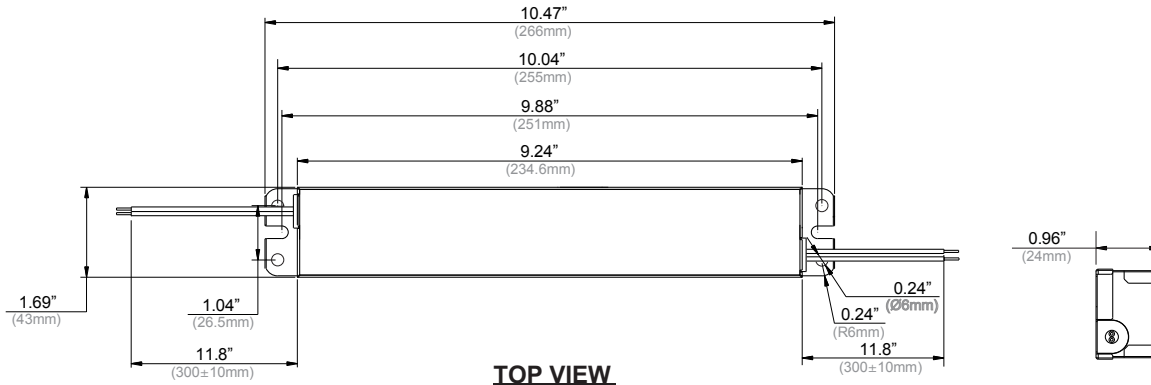

Overall Dimensions	
Length	10.47" [266mm]
Width	1.69" [43mm]
Height	0.96" [24 mm]
Wire Length	
AC Input (White/Black)	11.8" [300mm]
LED Output Red Blue	11.8" [300mm]

Case Tolerance=±0.02"[±0.5mm]

WIRING DIAGRAMS

THCV1UNV024V-100L



TOP VIEW

INPUT SIDE	LENGTH	OUTPUT SIDE	LENGTH
BLACK	11.8"[300mm]	RED	11.8"[300mm]
WHITE	11.8"[300mm]	BLUE	11.8"[300mm]

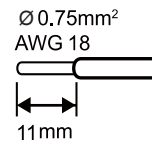



THCV1UNV024V-100L



Guidelines

Grounding

- Driver must be grounded by means of the Driver case.

Over temperature protection

- The Fulham ThoroLED drivers is protected against thermal overload. If the temperature limit is exceeded, the output current shut down.

LED load

- Fulham ThoroLED drivers are designed to drive passive LEDs, -COB's and -LED assemblies .Proper function is not guaranteed when (LED)loads with active components are used.

Short-circuit protection

- In case of a short circuit the LED driver switches to protection mode. After the removal of the short-circuit the LED driver will recover automatically.

No-load Operation

- In no-load operation the output voltage will not exceed the specified open circuit output voltage.

Hot Swapping

- This driver does not support hot swapping of the LEDs.

Remote Mounting

- Up to 50ft with 18AWG. Contact Fulham for higher remoute distance.

Service life/Lifetime

- Failure Rate Info based upon MTBF modeling: 90% survivals at end of life @ $\leq T_c$ lifetime rating.

Warranty

- Reference Fulham's limited Warranty: <https://cdn.fulham.com/PDFs/Limited-Warranty.pdf>

Part Number Matrix

TH CV 1 UNV 024V 100 L

LED Driver	Constant Voltage	# of Control Channels	Input Voltage	Output Voltage	Max. Output Power	Case Type
TH = ThoroLED		1 = 1 Channels	UNV = 120V~277V	024V = 24V	100 = 100W	L = Long

Product Image: LED Driver

THCV1UNV024V-100L



Packaging

Master Carton

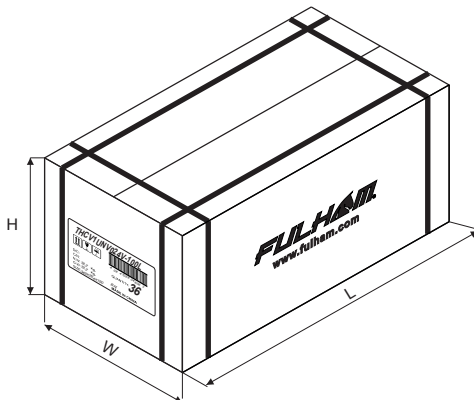

OUTER DIMENSION		
L	W	H
13.74"(349mm)	11.57"(294mm)	7.48"(190mm)
Net Weight	Gross Weight	QUANTITY
40.1 lbs . (18.2 kg)	42.3 lbs. (19.2 kg)	36pcs.